

# Water Management: Clearing Cloudy and Muddy Water in Ponds and Lakes

**T.L. Provin and J.L Pitt**

*Professor and Soil Chemist, Program Specialist*

*Texas A&M AgriLife Extension Service Soil, Water and Forage Testing Laboratory*

*Department of Soil and Crop Sciences*



Cloudy or muddy water and ponds can be aesthetically unpleasing and potentially dangerous. While swimmers will often avoid such waters simply because of aesthetics, debris and the unknown may lurk below the surface. Anything from broken glass, trash and roots to potentially dangerous wildlife can quickly turn a fun filled afternoon into a tragedy. Additionally, muddy water can be detrimental to aquatic life by reducing sunlight penetration, thereby limiting food production for game fish and other aquatic animals. Cloudy water interferes with the ability of certain fish, including bass, to see and capture prey. Muddy waters may impart a bad flavor to fish. Such waters also can promote the undesirable growth of blue-green algae and bacteria.

## **Causes of Cloudy, Muddy Water**

It is important to determine the cause of the cloudiness, or turbidity, in order to properly treat the water. Turbidity is simply the measurement of water clarity which may be due to suspended solids, algae, and/or dissolved organic materials. The most common cause of pond turbidity is the presence of suspended particles, mainly clay, in ponds. The extremely small size of the clay particles results in continual re-suspension due to changes in water temperature, wind, and/or water movement.

## How do the clay particles get suspended in the first place?

The primary source of suspended clay particles is soil erosion. Rainfall runoff, can dislodge clay particles particularly from over-grazed pastures, bare croplands, and exposed shorelines and transport it across the land surface to waterways. Compacted soils, soils with limited water filtration capacity and soils on moderate to strong slopes are particularly prone to erosion, unless care is taken to maintain a good vegetative or crop residue cover on the surface.



*Photos courtesy of USDA-NRCS*



*Photos courtesy of USDA-NRCS*

While wave erosion is a natural process, it can be significantly magnified by livestock trampling of the shoreline and wading in the ponds. This can suspend sediment and also may contribute large quantities of manure.

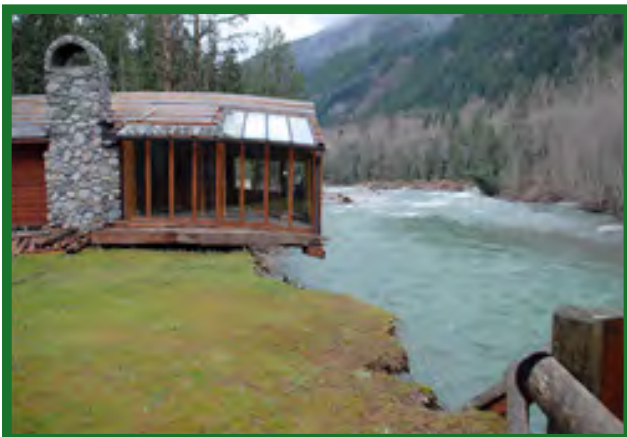

*Photo courtesy of USDA-NRCS*



*Photo courtesy of Lynn Betts, USDA-NRCS.*

Other animals, including feral hogs, deer, ducks and geese also can contribute to shoreline deterioration and/or stirring of bottom sediment. Furthermore, the activity of bottom-feeding fish such as carp and bullheads also can affect water clarity. These animals root and stir up the bottom sediments in search of food.

In some cases, intermittent turbidity of water can simply be the result of high winds, rapid changes in air temperature or recent high levels of precipitation. Each of these events can result in thermal currents occurring within the pond resulting in movement of water and sediment at the bottom. These thermal currents are more likely to occur in shallow ponds or on the ends of ponds. Prior to initiating any remediation steps, wait a week or two after the weather condition has passed to evaluate if sediment is settling.

## **How do I determine the cause of the problem?**

Limited cloudiness often observed following a rainfall event will usually clear within a few days. The cause is typically re-suspension of sediment on the bottom of the pond due to inflow. Cloudiness that remains longer than a few days may indicate a more serious problem that should be addressed to maintain the quality of the pond and prevent future water quality impairments.



*Photo courtesy of Russ Kirth, USDA-NRCS*



*Photo courtesy of USDA-Forest Service*

Biological causes are due to animal activity around or in the pond. To a lesser degree, the activity of ducks and geese may also impair the water quality. The activity of bottom-feeding fish such as carp and bullheads along with crayfish can also affect the clarity of the water. These animals root and stir up the bottom sediments in search of food.

If a cloudy or muddy condition persists for more than a few days, it will be necessary to determine the primary cause of the problem. First, take a water sample and let it set undisturbed for 24

hours. If the sediment settles and the water clears, the problem is likely re-suspension by some type of activity. For example, too many nuisance fish or cattle wading in the pond may be stirring up the sediment. Alternatively, the water may be too shallow which allows the wind to keep sediments suspended. If the sediment remains suspended, the problem may be due to the chemistry of the water and chemical treatment may be necessary.

## **How do I prevent or correct cloudy or muddy water?**

Prevention is the best means for eliminating the need for remedial action to clear a muddy pond. It is easier to keep soils, especially clay soils, from entering water than to remove them. The following factors can help minimize or prevent soil erosion and disturbance of pond sediments:

1. Match the watershed size to the pond size when planning a pond. In general, 10 – 15 acres of watershed land will support one surface acre of pond. The required watershed size is dependent on multiple factors including climate, soil types, and soil slopes within the watershed, and depth of the pond.



2. Maintain vegetative cover in the watershed area. In production agriculture areas, hay crops provide much better erosion control than row crops.



3. If cover crops can not be maintained in the watershed area, utilize wide vegetative buffer strips around the pond to trap sediment before it can enter the water.



4. Do not stock ponds with nuisance fish such as carp, goldfish or bullheads, instead, stock pond with largemouth bass or other predator fish that can control the nuisance fish. If nuisance fish already are present, they should be removed. Drain or seine the pond to remove the undesired fish. If these approaches are not practical, fish toxicants can be used. The labeling for fish toxicants may change over time. A current reference of fish toxicants is listed in the reference section of this publication.



5. Limit the access of cattle to the pond to prevent erosion of banks and disturbance of shallow waters. Further information on best management practices to prevent erosion caused by grazing cattle is available in “Lone Star Healthy Streams: Beef Cattle Manual,” B-6245, available at [agriflifebookstore.org](http://agriflifebookstore.org).



6. Keep ducks and geese away from the pond. This is particularly important if the pond or stream has very shallow water near the shores, as the webbed feet of these birds will constantly stir up sediment. Discourage foraging around the pond using annoyance techniques such as air cannons or dogs to scare the birds away. Products that can be applied to vegetation around the pond to make the vegetation unpalatable are also available. Domestic ducks or geese (ie. Pekin, Rouen, and etc.) should be limited to one pair per surface acre.

7. Limit introduction of organic matter and organic carbon into pond. While using hay or other organic matter is suggested to clear muddy waters, these practices can have negative results to water quality and aquatic life. Caution must be exercised when using organic matter as decomposition of the material can lead to low oxygen levels and fish kills. Organic matter should not be used in ponds with a history of fish kills or during summer months when dissolved oxygen levels may already be limiting. If organic applications must be made during the summer months, supplemental aeration may be needed to prevent fish kills.

## **Chemical Treatment of Ponds**

If the cause of turbidity is chemical in nature, gypsum (calcium sulfate), Epson salts (magnesium sulfate), aluminum sulfate (alum), or limestone (calcium carbonate) can be used to clear muddy ponds by removing suspended clay particles. Gypsum is a neutral salt and will not affect the pH of the pond. Although aluminum sulfate is most effective for settling clay particles, it can decrease the pH in some waters such that aquatic life may be harmed. This is a major concern for ponds in East Texas, that typically have low pH and total alkalinity. The generic term for “East Texas” ponds refers to the ponds located in the higher rainfall areas of the eastern portion of the state where the soils around and in the pond are comprised of lower clay and lower buffering capacity soils. The rapid recharge of these ponds often results in very low.

### **Which treatment to use?**

The selected amendment is largely dependent on pond water chemistry, availability of product and application capacity. Waters lower in pH or alkalinity are not good candidates for the use of aluminum sulfate. Aluminum sulfate will further lower the water pH and alkalinity creating additional problems. A good water test is needed prior to any treatment process. If the pH is below 7.0, and the alkalinity is below 50 ppm, limestone is likely the best choice. However, if aluminum sulfate is used, ground limestone will likely need to also be applied to improve the pH and alkalinity levels. A post-application water test should always be performed following additions of aluminum sulfate. Ground limestone, while inexpensive and easily available, has very low solubility and therefore must be mixed in a slurry and then sprayed across the water surface. Unfortunately, the majority of limestone will sink to the bottom of the pond and be covered by sediment rendering it ineffective for continued clay settling. Magnesium sulfate is normally the most soluble product, but its availability is often limited relative to gypsum.

The application method will also dictate selection. Both aluminum sulfate and ground limestone are best applied in slurries across as large of the surface area of the pond possible. This extremely large surface area requirement is to maximize treatment to muddy water contact and in the case of aluminum sulfate, minimize the localized water pH depression. Gypsum and Epson salts allow for continued dissolution and as a result, the extensive surface spreading required for limestone and aluminum sulfate is reduced, however overall efficacy improves by increasing the surface area of the pond receiving treatment. Tests should be run to determine the amount of treatment product required.

# Calculation of Chemical Amendments

To determine the amount of gypsum, Epsom salts, aluminum sulfate or ground limestone amendment needed, obtain six one gallon glass jars. Fill 5 jars with the cloudy/muddy pond water. Reserve one jar of pond water as a control for comparison. The sixth jar is used to prepare the test solution. This jar should be filled with clear water that is not affected (collected rainwater is best, or obtain water from a nearby clear ponds or stream). The remaining four jars are treated at various rates of test solution to determine the rate that provides the best clearing of the water. Use the following procedure:

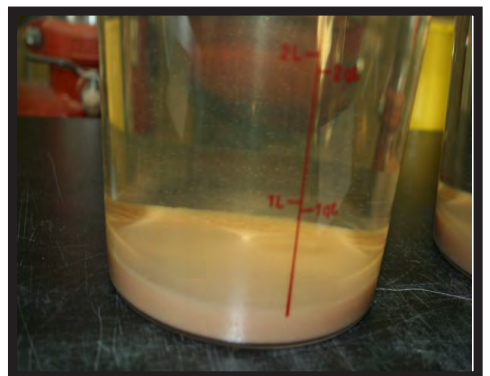
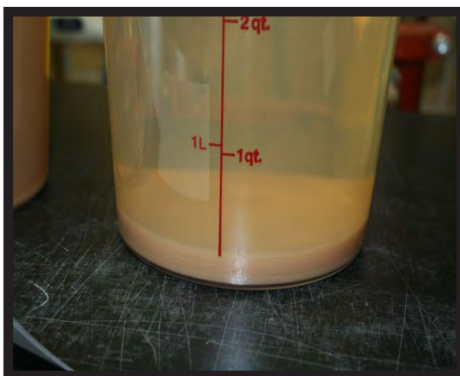
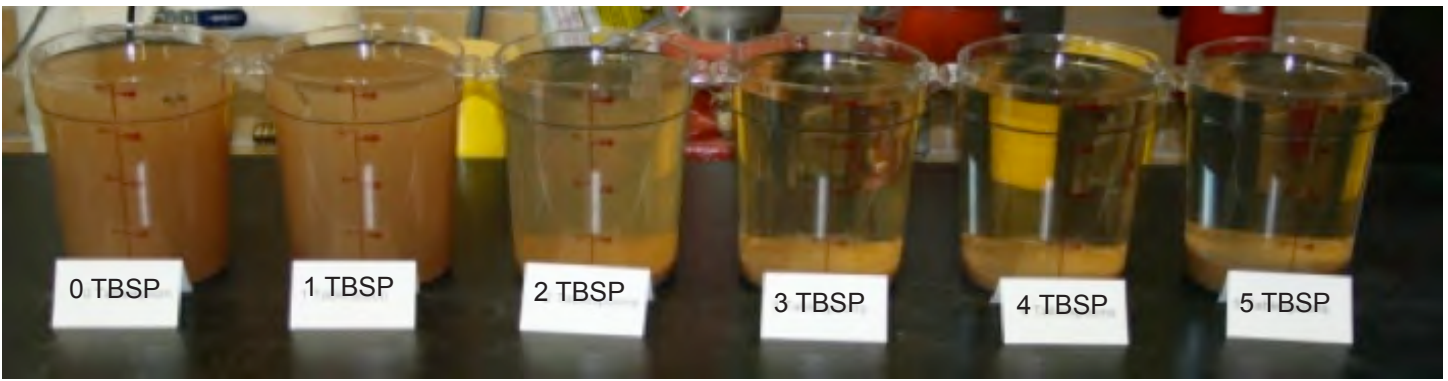



1. **Gypsum, Epsom Salts, or Limestone.** Using a standard measuring spoon, add two level teaspoons of gypsum to the gallon of clear water. Stir until the gypsum is in a slurry. Add different amounts of slurry to individual test jars. Allow the test jars to set undisturbed for 12 hours. The minimum amount of slurry that clears the water will be used to determine the amount of amendment to apply based on the following table.

Number of Tablespoons of Slurry Added to One Gallon Test Jar	Rate of Amendment to Apply to Pond (lbs/acre-foot) Based on 12 Hour Clearing
1	80
2	160
3	240
4	320
5	400
6	480
7	560
8	640
9	720
10	800
11	880
12	960

2. **Aluminum Sulfate (alum).** Using a standard measuring spoon, add one level teaspoon of alum to a gallon of clear water. Stir until the alum is in a slurry. Add different amounts of the slurry to individual test jars. Allow the test jars to set undisturbed for 12 hours. The minimum amount of slurry that clears the water will be used to determine the amount of alum to apply based on the following table. Hydrated lime (also referred to as burnt lime) can be utilized; however, the highly caustic nature of this material and risk of over elevating the water pH should be evaluated prior to using the material.

Number of Tablespoons of Slurry Added to One Gallon Test Jar	Rate of Alum to Apply to Pond (lbs/acre-foot) Based on 12 Hour Clearing	Amount of Hydrated Lime to Add (lbs/acre-foot) for East Texas Ponds	Amount of Hydrated Lime to Add (lbs/acre-foot) for non-East Texas Ponds
1	30	13	0
2	60	23	0
3	90	39	13
4	120	52	17

## Determining the Total Amount of Amendment Needed

In order to determine the total amount of amendment that will be needed to treat the pond, the volume of the pond must be determined. To calculate pond volume, both the surface area and the depth of the pond must be known.

The first step is to calculate the surface area of the pond in acres. For ponds that are somewhat circular, rectangular, triangular, or some other standard geometric shape, estimating the surface area is fairly straight forward. For irregularly shaped ponds, divide the pond into workable shapes, calculate the area of each, and total the individual areas. Measurements of the diameter, length and width of the pond or divisions of the pond should be made to the nearest foot. Some basic terms to consider when calculating the surface area are:

1 acre = 43,560 square feet, ft<sup>2</sup>

1 acre-foot = 1 surface acre by 1 foot deep or 43,560 cubic feet

Surface area in acre-feet = surface area divided by 43,560 square feet

Total volume in acre-feet = surface area in acres x average depth in feet

Radius, r = ½ diameter of a circle

Pi,  $\pi$  = 3.14

## Calculating Pond Surface Area

The following equations can be used to calculate the surface area:

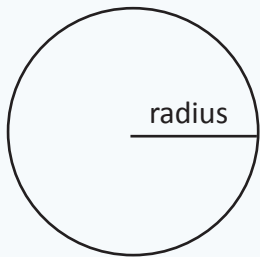

CIRCLE =  $\pi r^2$

**Example:** pond radius is 100 feet.  $3.14 \times 100 \times 100 = 31,400 \text{ ft}^2$  total surface area.  $31,400 \text{ ft}^2 / 43,560 \text{ ft}^2/\text{acre} = .72 \text{ acre}$



RECTANGLE = width x height

**Example:** pond length 150 feet x width 70 feet = 10,500 ft<sup>2</sup> total surface area.  $10,500 \text{ ft}^2 / 43,560 \text{ ft}^2/\text{acre} = .25 \text{ acre}$

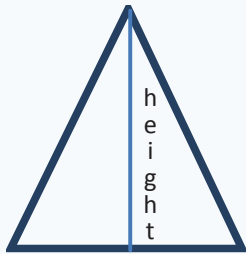

base



base

$$\text{TRIANGLE} = \frac{1}{2} (\text{base} \times \text{height})$$

**Example:**  $\frac{1}{2} \times$  pond base 285feet  $\times$  (triangles with equal sides height 75 feet = 10,688 ft<sup>2</sup> total or a right angle) surface area. 10,688 ft<sup>2</sup>/43,560 ft<sup>2</sup>/acre = .25 acre

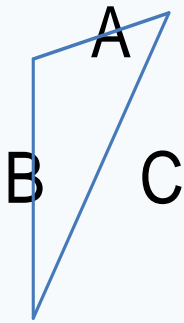

$$\text{TRIANGLE} = \sqrt{S(S-A) \times (S-B) \times (S-C)}$$

**Example:** A = 100 feet, B = 120

Where S =  $\frac{1}{2}(A+B+C)$  feet and C = 80 feet. S =  $\frac{1}{2}(100+120+80) = 150$ .

$\sqrt{150(150-100) \times (150-120) \times (150-80)} = 3968$  ft<sup>2</sup> total surface area.

= 3968 ft<sup>2</sup>/43,560 ft<sup>2</sup>/acre = .09 acre

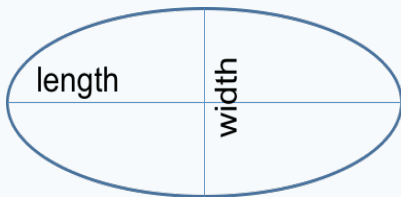

$$\text{ELLIPSE} = \frac{1}{4}\pi \times \text{length} \times \text{width}$$

**Example:**  $\frac{1}{4} \times 3.14 \times$  pond length 375 feet  $\times$  width 75 feet = 22,078 ft<sup>2</sup> total surface area.

2,078 ft<sup>2</sup>/43,560 ft<sup>2</sup>/acre = .5 acre

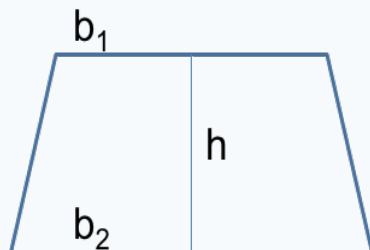

$$\text{TRAPEZOID} = \frac{1}{2} (b_1 + b_2)h$$

**Example:**  $\frac{1}{2} (100 \text{ feet} + 180 \text{ feet}) 75 \text{ feet} = 10,500$  ft<sup>2</sup> total surface area.

10,500 ft<sup>2</sup>/43,560 ft<sup>2</sup>/acre = .24 acre

**Figure 1** shows a more complex, pentagon-shaped pond. This pond can be divided into a trapezoid and triangle for calculating the area. **Figure 2a** shows a kidney shaped pond. The pond can be divided into two ellipses and one trapezoid for calculating the area. In the real world most ponds will not fit standard geometric shapes perfectly. As such, good estimates should suffice for irregularly shaped ponds.

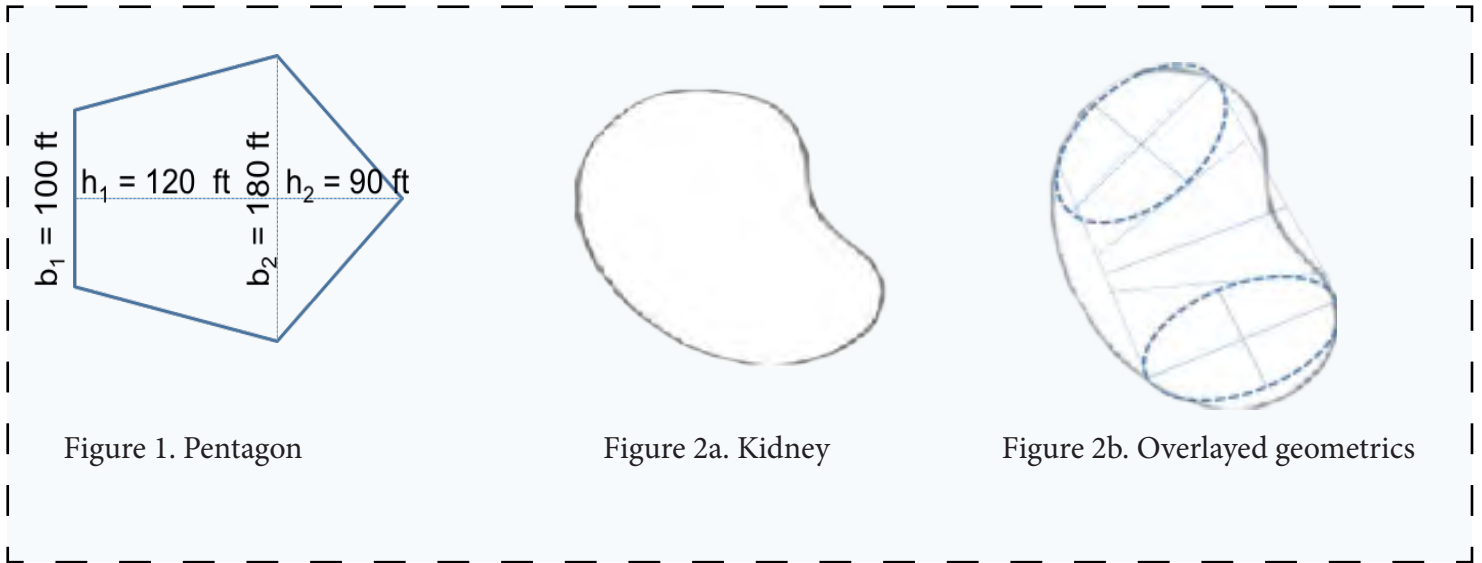

***Other tools available for determining surface area***

A number of mapping programs are available that utilize scaled aerial maps. The programs allow the user to outline the edge of larger ponds for the automatic calculation of the pond surface area. The use of these programs requires a map with accurate scale references, as well as, relatively high level of resolution. These programs are generally limited use with to larger ponds and lakes, but do provide very accurate and quick estimates of surface area.

**Calculating pond depth**

The second step is to determine the average depth of the pond. Take a minimum of 15 depth measurements spaced throughout the pond. Add the measurements and divide by the number of measurements. This will be the average depth of the pond. The measurements can be acquired through the use of an electronic depth or fish finder, or simply with a weight attached to a string or rope that is marked in feet. Use a ruler to measure the number of inches above the last foot marker and record the depth at each location.

To calculate the acre-feet of the pond, multiply the surface area in acres by the average depth. In the example of the circular pond above, the surface area was .72 acres. If the pond has an average depth of 8 feet, the acre-feet of the pond is .72 acres x 8 feet or 5.76 acre-feet. This calculation holds true for regularly shaped ponds with fairly vertical sides.

The calculations will be slightly different for ponds with gradually or steeply sloping sides. In these cases, calculate the volume of the pond in cubic feet and divide by 43,560 ft<sup>2</sup>/acre. The shapes to consider are circular with very gradual slope, circular with moderate slope, circular with steep slope, rectangular with gentle slope and rectangular with steep slope.

## Circular Ponds

Circular ponds with very gradual slopes have a hemispheric shape. The volume will be calculated based on the volume of a hemisphere where the radius,  $r$ , is the maximum depth of the pond.

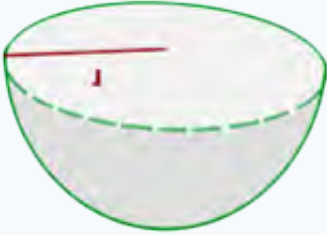

$$\text{HEMISPHERE} = \frac{2}{3}\pi \times r^3$$

**Example:**  $\frac{2}{3} \times 3.14 \times 18 \text{ feet depth} \times 18 \text{ feet} \times 18 \text{ feet} = 12,208 \text{ ft}^3$ .  
 $12,208 \text{ ft}^3 / 43,560 \text{ ft}^2/\text{acre} = .28 \text{ acre-feet}$

Circular ponds with moderately sloping sides can be described by a truncated cone shape. The height,  $h$ , is the maximum depth of the pond,  $r_1$  is the radius of the surface and  $r_2$  is the estimated radius of the bottom of the pond. For the example,  $r_1 = 65$  feet,  $r_2 = 45$  feet, and the height is 14 feet.

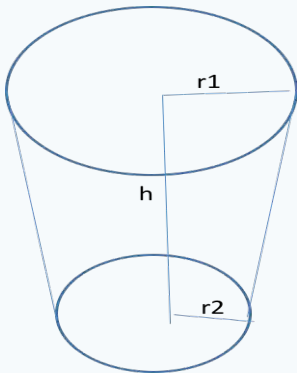

$$\text{TRUNCATED CONE} = \frac{1}{3} \pi h \times [r_1^2 + r_2^2 + (r_1 \times r_2)]$$

**Example:**  $\frac{1}{3} \times 3.14 \times 14 [ 65 \text{ feet} \times 65 \text{ feet} + 45 \text{ feet} \times 45 \text{ feet} + (65 \text{ feet} \times 45 \text{ feet}) ] = 134,444 \text{ ft}^3$ .  $134,444 \text{ ft}^3 / 43,460 \text{ ft}^2/\text{acre} = 3.1 \text{ acre-feet}$

Circular ponds with very steep sides can be described by a cone shape. The height,  $h$ , is the maximum depth and, the radius,  $r$ , is the radius of the circle. For the example,  $r = 65$  feet, and the height is 14 feet.

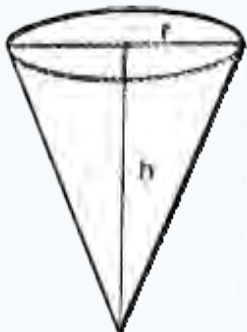

$$\text{Cone} = \frac{1}{3} \pi r^2 h$$

**Example:**  $\frac{1}{3} \times 3.14 \times 65 \text{ feet} \times 65 \text{ feet} \times 14 \text{ feet} = 61,910 \text{ ft}^3$ .  $61,910 \text{ ft}^3 / 43,460 \text{ ft}^2/\text{acre} = 1.42 \text{ acre-feet}$

## Rectangular Ponds

Rectangular ponds with gradual to moderate slopes have a truncated pyramid shape. The height,  $h$ , is the average maximum depth,  $a$  and  $b$  are the width and length of the lower face of the pond, and  $c$  and  $d$  are the width and length of the upper face of the pond. For the example,  $a = 20$  feet,  $b = 30$  feet,  $c = 50$  feet,  $d = 70$  feet, and  $h = 20$  feet.

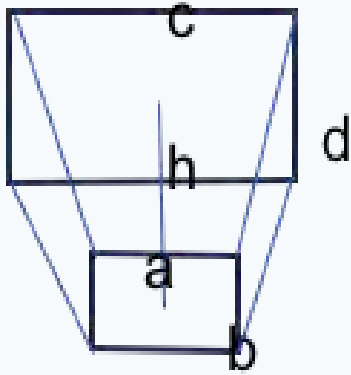

$$\text{TRUNCATED PYRAMID} = \frac{1}{3}h(ab + cd + \sqrt{abcd})$$

**Example:**  $\frac{1}{3} \times 20$  feet  $(20$  feet  $\times 30$  feet  $+ 50$  feet  $\times 70$  feet  $+ \sqrt{20 \times 30 \times 50 \times 70}) = 36,994$  ft<sup>3</sup>.  $36,994$  ft<sup>3</sup>/ $43,460$  ft<sup>2</sup>/acre = .85 acre-feet

Rectangular ponds with very steep slopes can be described by a pyramid shape. The height,  $h$ , is the maximum depth,  $l$  is the length of one the side of the pond, and  $w$  is the width of the other side. For the example,  $h = 10$  feet,  $l = 50$  feet, and  $w = 40$  feet.

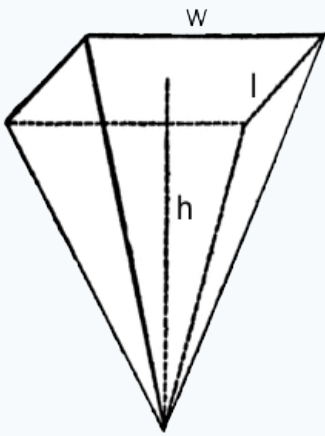

$$\text{PYRAMID} = \frac{1}{3}lwh$$

**Example:**  $\frac{1}{3} \times 50$  feet  $\times 40$  feet  $\times 10$  feet =  $6,666$  ft<sup>3</sup>.  $6,666$  ft<sup>3</sup>/ $43,460$  ft<sup>2</sup>/acre = .15 acre-feet

## Non-chemical Treatments

The most common non-chemical treatment is the surface application of hay. Hay aids in the settling of suspended clays through the release of organic acids that form clay-organic acid complexes which settle to the pond bottom. For the hay to be most effective, high quality, lower fiber hay must be used to provide high organic acid concentrations. While using hay can be effective, oxygen depletion due to degradation of the hay by bacteria can be a major concern. Additionally, some hays may release tannins and other organics that may affect water color. The rate of hay application to a pond is largely an unknown, as hay sources and hay quality vary considerably. Calibrating hay application rates is very difficult to undertake, as the outlined jug method does not lend itself well to hay additions. Because the lack of calibration capacity and widely differing hay qualities, coupled with the impact of over-application of organic matter to the pond, the use of hay as a method of clearing pond water is highly discouraged.

## References

Burns, Robert. 2006. Pond owners with muddy waters don't have to sing the blues. AgNews, March 31, 2006. Texas A&M University System.

Helfrich, L.A. and T. Newcomb. 2009. Clearing muddy pond waters. Virginia Cooperative Extension Pub. No. 420-250. Virginia State University. <http://pubs.ext.vt.edu/420/420-250>

Lynch, William E. and Eric R. Norland. 2001. Muddy water in ponds causes, prevention, and remedies. Ohio State University Extension Fact Sheet A-6-01.

Ohio Department of Natural Resources. Ohio pond management pond problems & solutions: muddy water. <http://www.dnr.state.oh.us/wildlife/Home/fishing/pond/muddy/tabid/6231/Default.aspx>

Steinbach, Don and Billy Higginbotham. 1985. Clearing muddy ponds. Texas AgriLife Extension Service Pub. No. L-2161. Texas A&M University.

[http://agrifeweb.tamu.edu/wildlife/files/2010/05/4\\_Clearing\\_Muddy\\_Ponds.pdf](http://agrifeweb.tamu.edu/wildlife/files/2010/05/4_Clearing_Muddy_Ponds.pdf)

[http://agrifeweb.tamu.edu/wildlife/files/2010/05/4\\_Interaction\\_of\\_pH.pdf](http://agrifeweb.tamu.edu/wildlife/files/2010/05/4_Interaction_of_pH.pdf)

<https://srac.tamu.edu/index.cfm/event/getFactSheet/whichfactsheet/219/>

<http://aquanic.org/jsa/wgqaap/drugguide/Appendix-B%20-Table-2-fish-toxicants.htm>

Produced by the Department of Soil and Crop Sciences  
[soilcrop.tamu.edu](http://soilcrop.tamu.edu)

The information given herein is for educational purposes only. Reference to commercial products or trade names is made with the understanding that no discrimination is intended and no endorsement by the Texas A&M AgriLife Extension Service is implied.

TEXAS A&M AgriLife Extension Service

[AgriLifeExtension.tamu.edu](http://AgriLifeExtension.tamu.edu)

*Educational programs of the Texas A&M AgriLife Extension Service are open to all people without regard to race, color, sex, disability, religion, age, or national origin*

---

*The Texas A&M University System, U.S. Department of Agriculture, and the County Commissioners Courts of Texas Cooperating*